

dyson big ball

Operating manual

Assembly

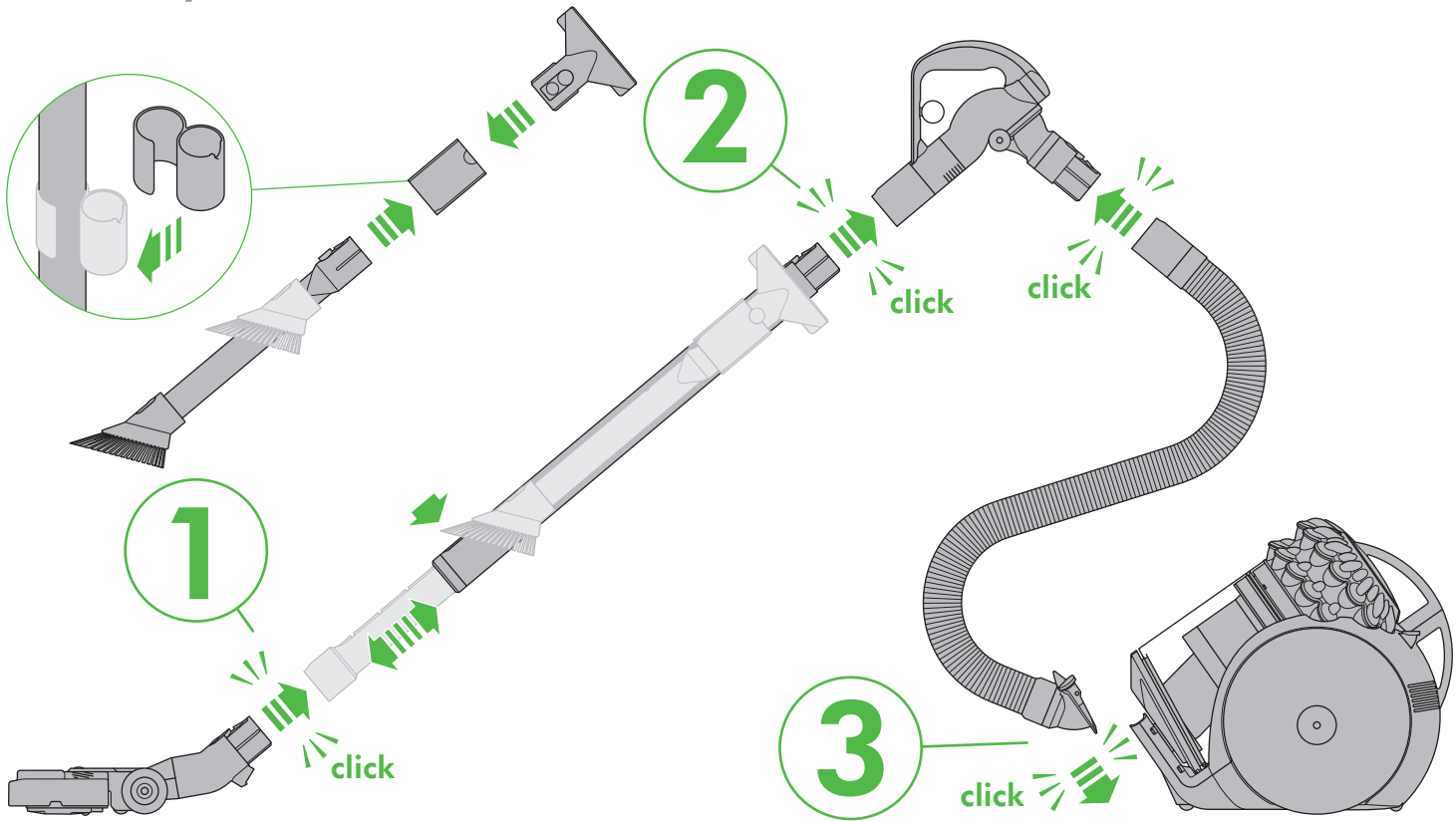

Wash filter

Wash filter with cold water at least once every month.



Register
your free 5 year
guarantee today

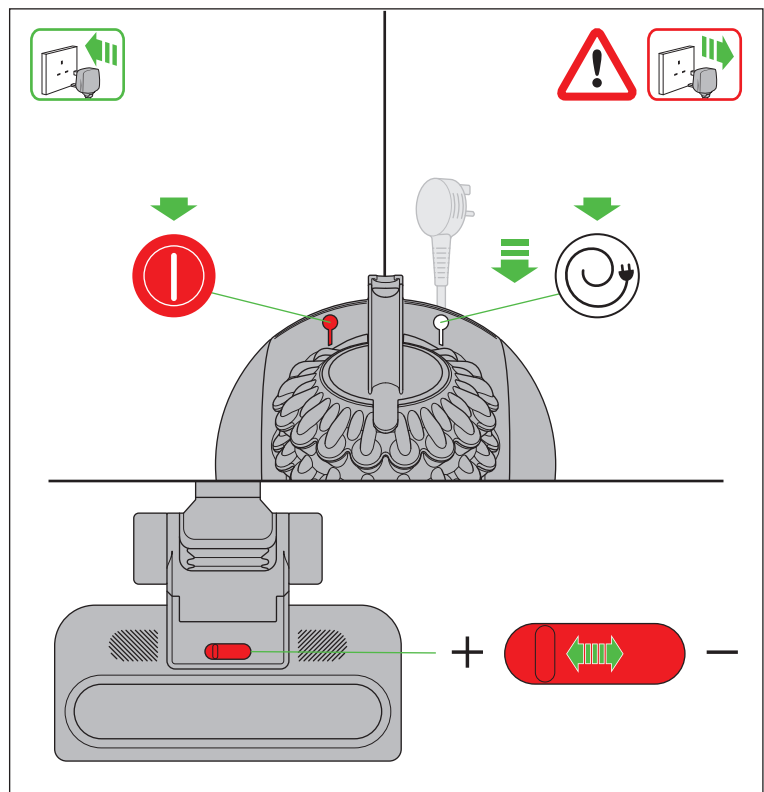

Dyson customer care

Thank you for choosing to buy a Dyson appliance.

After registering your 5 year guarantee, your Dyson appliance will be covered for parts and labour for 5 years from the date of purchase, subject to the terms of the guarantee. If you have any queries regarding your Dyson appliance, visit www.dyson.co.uk/support (UK) or www.dyson.ie/support (ROI) for online help, general tips and useful information about Dyson.

Alternatively, you can call the Dyson Helpline with your serial number and details of where/when you bought the appliance.

Dyson contact details

UK:

Website: www.dyson.co.uk/support

Dyson helpline:

0800 298 0298

Email:

askdyson@dyson.co.uk

Address:

Dyson Technology Limited, Tetbury Hill, Malmesbury, Wiltshire, SN16 0RP

ROI:

Website: www.dyson.ie/support

Dyson helpline:

01 475 7109

Email:

askdyson@dyson.ie

Address:

Dyson Ireland Limited, Office 2, Central Park, Leopardstown, Dublin 18, Ireland

Your serial number can be found on your rating plate which is on the main body of the appliance behind the clear bin.

Note your serial number for future reference.



This illustration is for example purposes only.

IMPORTANT SAFETY INSTRUCTIONS

BEFORE USING THIS APPLIANCE READ ALL INSTRUCTIONS AND CAUTIONARY MARKINGS IN THIS MANUAL AND ON THE APPLIANCE

When using an electrical appliance, basic precautions should always be followed, including the following:

WARNING

These warnings apply to the appliance, and also where applicable, to all tools, accessories, chargers or mains adaptors.

TO REDUCE THE RISK OF FIRE, ELECTRIC SHOCK OR INJURY:

1. This Dyson appliance can be used by children aged from 8 years and above and persons with reduced physical, sensory or reasoning capabilities, or lack of experience and knowledge, only if they have been given supervision or instruction by a responsible person concerning use of the appliance in a safe way and understand the hazards involved. Cleaning and user maintenance shall not be made by children without supervision.
2. Do not allow to be used as a toy. Close attention is necessary when used by or near children. Children should be supervised to ensure that they do not play with the appliance.
3. Use only as described in this Dyson Operating Manual. Do not carry out any maintenance other than that shown in this manual, or advised by the Dyson Helpline.

3 easy ways to register your free 5 year guarantee

Register online



Visit our website to register your full parts and labour guarantee online.

www.dyson.co.uk/register
www.dyson.ie/register

Register by phone



Call our dedicated helpline.
Open Monday to Friday
8am-8pm & Saturday and
Sunday 8am-6pm.

UK: 0800 298 0298
ROI: 01 475 7109

Register by mail



Complete and return the form to Dyson in the envelope supplied.

4. Suitable for dry locations ONLY. Do not use outdoors or on wet surfaces.
5. Do not handle any part of the plug or appliance with wet hands.
6. Do not use with a damaged cable or plug. If the supply cable is damaged it must be replaced by Dyson, its service agent or similarly qualified person in order to avoid a hazard.
7. If the appliance is not working as it should, has received a sharp blow, has been dropped, damaged, left outdoors, or dropped into water, do not use and contact the Dyson Helpline.
8. Contact the Dyson Helpline when service or repair is required. Do not disassemble the appliance as incorrect reassembly may result in an electric shock or fire.
9. Do not stretch the cable or place the cable under strain. Keep the cable away from heated surfaces. Do not close a door on the cable, or pull the cable around sharp edges or corners. Arrange the cable away from traffic areas and where it will not be stepped on or tripped over. Do not run over the cable.
10. Do not unplug by pulling on the cable. To unplug, grasp the plug, not the cable. The use of an extension cable is not recommended.
11. Do not use to pick up water.
12. Do not use to pick up flammable or combustible liquids, such as petrol, or use in areas where they or their vapours may be present.
13. Do not pick up anything that is burning or smoking, such as cigarettes, matches, or hot ashes.
14. Keep hair, loose clothing, fingers, and all parts of the body away from openings and moving parts, such as the brush bar. Do not point the hose, wand or tools at your eyes or ears or put them in your mouth.
15. Do not put any object into openings. Do not use with any opening blocked; keep free of dust, lint, hair and anything that may reduce airflow.
16. Use only Dyson recommended accessories and replacement parts.
17. To avoid a tripping hazard wind the cable when not in use.
18. Do not use without the clear bin and cyclone in place.

19. Do not leave the appliance when plugged in. Unplug when not in use and before servicing.
20. Do not pull or carry by cable or use cable as a handle.
21. Use extra care when cleaning on stairs. Do not work with the appliance above you on the stairs.
22. Turn off all controls before unplugging. Unplug before connecting any tool or accessory.
23. Always extend the cable to the red line but do not stretch or tug the cable.
24. Hold the plug when rewinding onto cable reel. Do not allow the plug to whip when rewinding.
25. **FIRE WARNING** – Do not apply any fragrance or scented product to the filter(s) of this appliance. The chemicals in such products are known to be flammable and can cause the appliance to catch fire.

READ AND SAVE THESE INSTRUCTIONS

This Dyson appliance is intended for household use only.

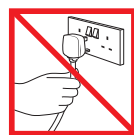

Do not pull on the cable.

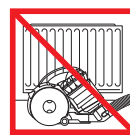

Do not store near heat sources.



Do not use near naked flames.



Do not run over the cable.



Do not pick up water or liquids.



Do not pick up burning objects.



Do not use above you on the stairs.



Do not put hands near the brush bar when the appliance is in use.

Power & cable

Diagram illustrating power and cable connections. A red circle with a vertical bar indicates the power switch. A warning triangle and a plug icon are shown. Green arrows indicate the correct way to connect the power cord to the machine and the wall outlet.

Suction release

Diagram illustrating suction release techniques. A hand is shown pressing a button on the handle. Green checkmarks and arrows indicate correct use on a carpet. Red X marks indicate incorrect use on a hard floor.

Self-adjusting cleaner head with suction control

Diagram illustrating the self-adjusting cleaner head with suction control. A red slider is shown in the 'Auto' position. Green arrows indicate the head adjusting to the floor surface.

Diagram illustrating various attachments and their use. A long extension tube is shown with a motor unit. A circular inset shows a close-up of the attachment mechanism. A 'click' sound is indicated.

Carpets or hard floors

Diagram illustrating the cleaner head on different floor types. A red X indicates the head is too high for a carpet. Green arrows and a circular arrow indicate the head adjusting to the floor.

Brush bar – clearing obstructions

Diagram illustrating how to clear obstructions from the brush bar. A warning triangle and a plug icon are shown. A hand is shown using a tool to clear the brush bar. A lock icon indicates the brush bar is locked.

Emptying the clear bin

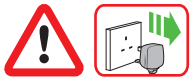

1

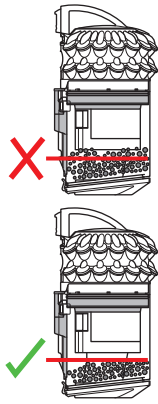
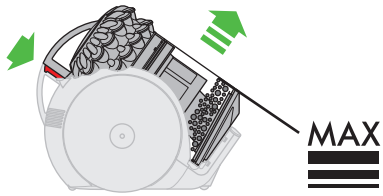

2

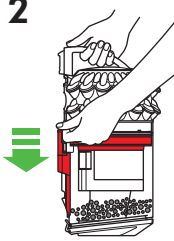

3

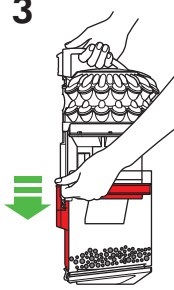

4

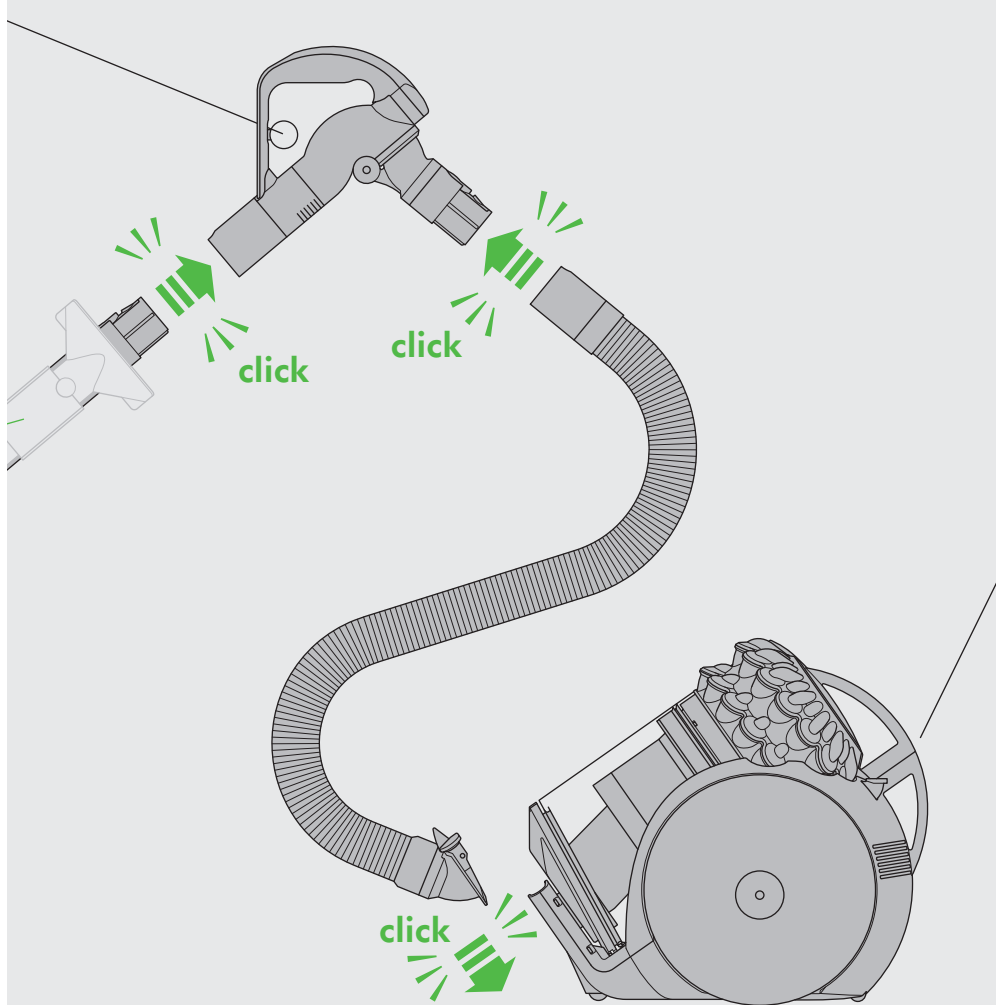
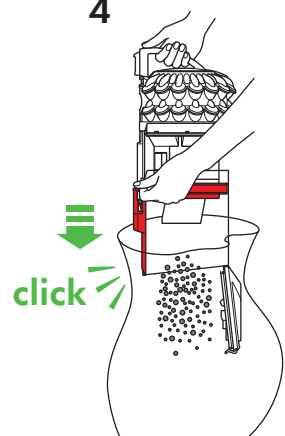

Carrying & storage

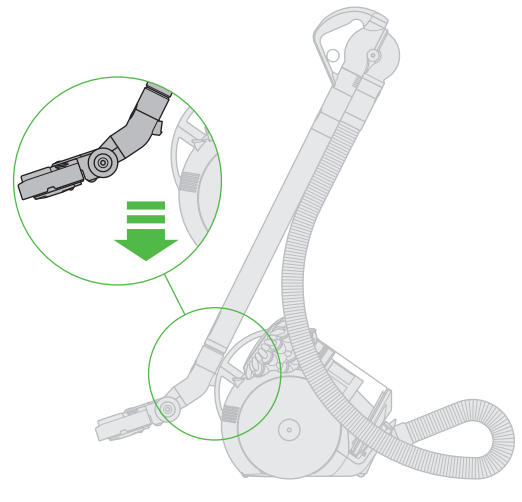
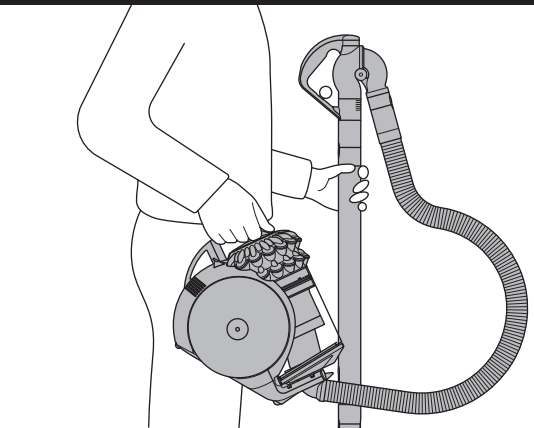

Looking for blockages

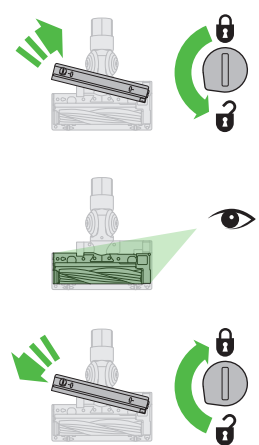
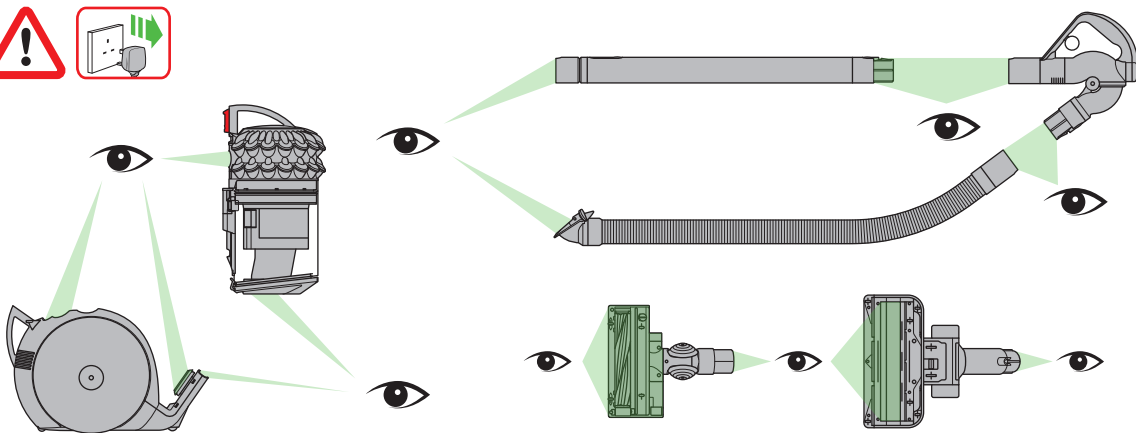
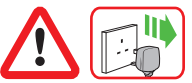

Emptying the clear bin and optional bin removal

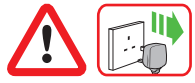

1

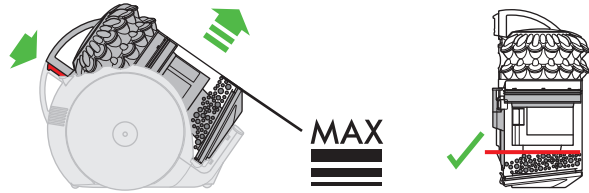

2

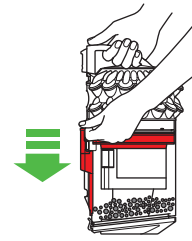

3

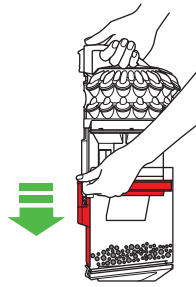

4

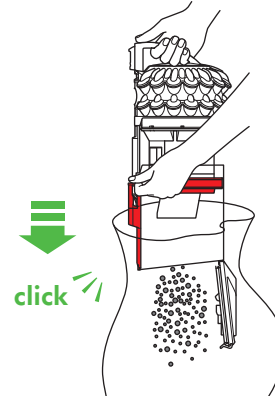

5

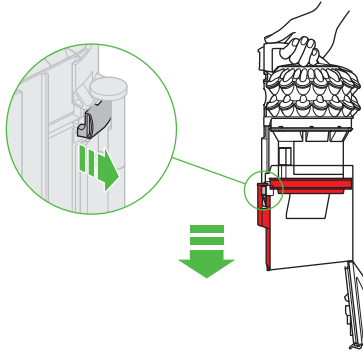

6

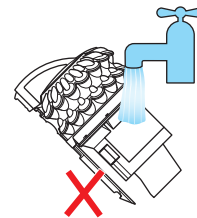

7

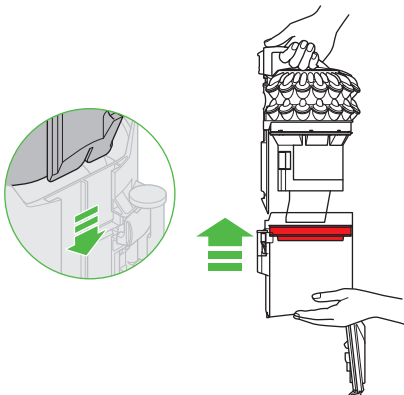

8

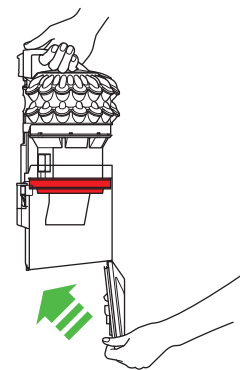

9

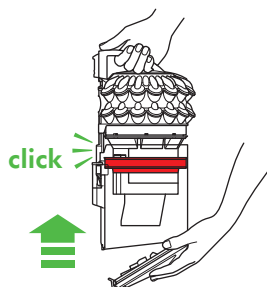

10



Important!

Wash filter

Wash filter with cold water at least once every month.



1

2

3

4

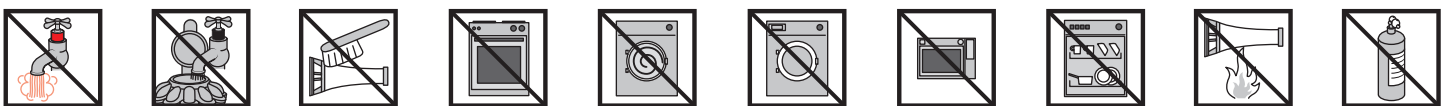

Using your Dyson appliance

Please read the 'Important Safety Instructions' in this Dyson operating manual before proceeding.

Carrying the appliance

- Carry the appliance by the main handle.
- Do not press the cyclone release button or shake the appliance when carrying or the cyclone could disengage, fall off and cause injury.

Operation

- Always extend the cable fully to the red tape before use.
- Plug the appliance into the mains electricity supply.
- To switch 'ON' or 'OFF' press the red power button, located as shown.
- After use: Unplug, push the cable retract button firmly until cable has fully retracted.
- Switch 'OFF' the appliance and unplug before:
 - Changing tools.
 - Removing the hose.

Self-adjusting cleaner head with suction control

- Your appliance has a self-adjusting cleaner head with suction control. This cleaner head is used for testing with the European Regulations: No. 665/2013 and No. 666/2013 and testing shall be performed in Max mode (+).

Easy mode (-)

Reduced push force for effortless cleaning.

- For vacuuming of lightly soiled carpets, rugs and hard flooring.
- Your appliance is pre-set to this level of suction when you take it out of the box.

Max mode (+)

Maximum suction for powerful dust and dirt removal.

- For vacuuming durable floor coverings, hard floors and heavily soiled carpets and rugs.
- To switch to this setting, move the suction control slider on top of the cleaner head as shown.
- CAUTION: The suction of this mode can damage delicate flooring. Before vacuuming, check the flooring manufacturer's cleaning recommendations.
- If the suction power of Max mode (+) prevents easy manoeuvrability, switch to Easy mode (-).

Carpets or hard floors

- The brush bar will always default to 'ON' (spinning) each time you switch the machine 'ON'.
- To switch the brush bar 'OFF' (e.g. for delicate flooring), twist the dial on the cleaner head a quarter of a turn. The brush bar will stop.
- When the appliance is running and the brush bar has been switched 'OFF', the brush bar can be switched 'ON' again by twisting the dial on the cleaner head a quarter of a turn. The brush bar will start. Alternatively, switch the appliance 'OFF'; the dial will return to its original position. When the appliance is switched 'ON' again the brush bar starts automatically.
- The brush bar can only be turned off once the machine is running.
- The brush bar will automatically stop if it becomes obstructed. See 'Brush bar – clearing obstructions'.
- Before vacuuming your flooring, rugs and carpets, check the manufacturer's recommended cleaning instructions.
- Some carpets may fuzz if a rotating brush bar is used when vacuuming. If this happens, we recommend vacuuming

with the brush bar switched 'OFF' and consulting with the carpet manufacturer.

- The brush bar on the appliance may damage some carpet types. If you are unsure, turn 'OFF' the brush bar.
- This appliance has carbon fibre brushes. Take care if coming into contact with them, as they may cause minor skin irritation. Wash your hands after handling the brushes.
- Check the brush bar regularly and clear away any debris (such as hair). Debris left on the brush bar may cause damage to flooring when vacuuming.

Vacuuuming

- Do not use without the clear bin and cyclone in place.
- Do not use on rubble, ash or plaster. This appliance is designed only for domestic use to remove household dirt, hair and allergens. The appliance is not designed to be used on:
 - debris produced from activities such as DIY, building or similar tasks
 - larger types and quantities of dust or debris, such as soot and sawdust.These materials may harm the appliance and may void your guarantee.
- Fine dirt such as flour should only be vacuumed in very small amounts.
- Do not use the appliance to pick up sharp hard objects, small toys, pins, paper clips, etc. They may damage the appliance.
- When vacuuming, certain carpets may generate small static charges in the clear bin or wand. These are harmless and are not associated with the mains electricity supply. To minimize any effect from this small static charge, do not put your hand or insert any object into the clear bin unless you have emptied it first, then cleaned it with a damp cloth (see 'Cleaning the clear bin').
- Do not work with the appliance above you on the stairs.
- Do not put the appliance on chairs, tables, etc.
- Before vacuuming highly polished floors, such as wood or lino, first check that the underside of the floor tool and its brushes are free from foreign objects that could cause marking.
- Do not push hard with the floor tool when vacuuming, as this may cause damage.

Blockages – thermal cut-out

- This appliance is fitted with an automatically resetting thermal cut-out.
- If any part becomes blocked the appliance may overheat and automatically cut-out.
- If this happens, follow the instructions in 'Looking for blockages'.
- NOTE: Large items may block the tools or wand inlet. If this happens, do not operate the wand release catch. Switch 'OFF' and unplug. Failure to do so could result in personal injury.

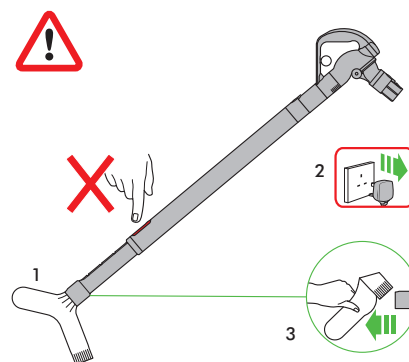

Looking for blockages

- Switch 'OFF' and unplug before looking for blockages. Failure to do so could result in personal injury.
- Leave to cool down for 1-2 hours before looking for blockages.
- Beware of sharp objects when checking for blockages.

- Clear any blockage before restarting.
- Refit all parts securely before using.
- Please refer to 'Looking for blockages' illustrations or 'Online support' section for additional guidance.
- To gain access to blockages behind the brush bar, remove the base plate by using a coin to loosen the fastener marked with a padlock.
- Clearing blockages is not covered by your guarantee.

Brush bar – clearing obstructions

- If your brush bar is obstructed, it may shut 'OFF'. If this happens you will need to remove the brush bar as shown.
- Switch 'OFF' and unplug before proceeding. Failure to do so could result in personal injury.
- Remove the brush bar by using a coin to loosen the fastener marked with a padlock until it clicks.
- Beware of sharp objects when clearing obstructions.
- Replace the brush bar and secure it by tightening the fastener until it clicks. Ensure it is fixed firmly before operating.
- Clearing brush bar obstructions is not covered by your guarantee.
- This appliance has carbon fibre brushes. Take care if coming into contact with them, as they may cause minor skin irritation. Wash your hands after handling the brushes.

Emptying the clear bin

- Empty as soon as the dirt reaches the level of the MAX mark – do not overfill.
- Switch 'OFF' and unplug before emptying the clear bin.
- To remove the cyclone and clear bin unit, push the red button on the top of the carrying handle, as shown.
- To release the dirt, firmly push the red bin release button.
 - The bin will slide down, cleaning the shroud as it goes.
 - The bin base will then open.
- The bin base will not open if the red button is not pushed down fully.
- To minimise dust/allergen contact when emptying, encase the clear bin tightly in a plastic bag and empty.
- Remove the clear bin carefully from the bag.
- Seal the bag tightly, dispose as normal.
- Close the clear bin by pushing the bin base upwards until it clicks into place.
- Push the bin base clip firmly until it clicks into position to ensure that the base is securely sealed.
- Align the base of the clear bin with the air hose inlet and then click back into place.

Cleaning the clear bin (optional)

In the event that it is necessary to clean the clear bin:

- Remove the cyclone and clear bin (see 'Emptying the clear bin').
- Open the bin base fully (see 'Emptying the clear bin').
- To separate the cyclone from the clear bin, pull the silver catch behind the red bin release button and slide the clear bin off the spine on the cyclone.
- Please refer to 'Emptying the clear bin and optional bin removal' illustrations for additional bin removal and replacing guidance.
- Clean the clear bin with a damp cloth only.
- Do not use detergents, polishes or air fresheners to clean the clear bin.
- Do not put the clear bin in a dishwasher.
- Do not immerse the cyclone in water or pour water into the cyclones.
- Ensure the clear bin is completely dry before replacing.
- To refit the clear bin:
 - Insert the spine into the bin runner
 - Push upwards until it clicks and then continue pushing until it slides home.
- Close the clear bin by pushing the bin base upwards. Ensure that the bin base clicks and the clip is securely in place.

Washing your filter

- Your appliance has one washable filter, located as shown.
- Check and wash the filter regularly according to instructions to maintain performance.
- Switch 'OFF' and unplug before checking or removing the filter.
- The filter may require more frequent washing if vacuuming fine dust.
- Wash the filter with cold water only. Hold under a tap and run water through the open end until the water runs clear. Turn upside down and tap out.
- Run water over the outside of the filter for 15 seconds.
- Squeeze and twist with both hands to make sure the excess water is removed.
- Do not put the filter in a dishwasher, washing machine, tumble dryer, oven, microwave or near a naked flame.
- IMPORTANT: After washing please leave at least 24 hours to dry completely before refitting.

Looking after your Dyson appliance

- Do not carry out any maintenance or repair work other than that shown in this Dyson Operating Manual, or advised by the Dyson Helpline.
- Only use parts recommended by Dyson. If you do not this could invalidate your guarantee.
- Store the appliance indoors. Do not use or store it below 3°C (37.4°F). Ensure the appliance is at room temperature before operating.
- Clean the appliance only with a dry cloth. Do not use any lubricants, cleaning agents, polishes or air fresheners on any part of the appliance.
- If used in a garage, always wipe the base of the floor tool and base of the appliance with a dry cloth after vacuuming to clean off any sand, dirt or pebbles that could damage delicate floors.

Disposal information

- Dyson products are made from high grade recyclable materials. Recycle where possible.

 This marking indicates that this product should not be disposed with other household wastes throughout the EU. To prevent possible harm to the environment or human health from uncontrolled waste disposal, recycle it responsibly to promote the sustainable reuse of material resources. To return your used device, please use the return and collection systems or contact the retailer where the product was purchased. They can take this product for environmentally safe recycling.

Online support

- For online help, general tips, videos and useful information about Dyson.
UK - www.dyson.co.uk/support
ROI - www.dyson.ie/support

Product information

Please note: Small details may vary from those shown.

Compatibility with previous Dyson tools and accessories

- Your new machine comes with the latest Dyson technology. As such it is equipped with the latest Quick release catches that allow quick and easy tool or accessory changes. However, this makes it incompatible with previous generations of Dyson products.
- An adaptor which makes your new machine compatible with older Dyson tools and accessories is available by contacting your local Dyson Helpline (see 'Dyson Customer Care' section for contact details).

Guarantee terms and conditions

Dyson customer care

Thank you for choosing to buy a Dyson appliance.

After registering your 5 year guarantee, your Dyson appliance will be covered for parts and labour for 5 years from the date of purchase, subject to the terms of the guarantee. If you have any queries regarding your Dyson appliance, visit www.dyson.co.uk/support (UK) or www.dyson.ie/support (ROI) for online help, general tips and useful information about Dyson. Alternatively, you can call the Dyson Helpline with your serial number and details of where/when you bought the appliance. If your Dyson appliance needs a repair, call the Dyson Helpline so we can discuss the available options. If your Dyson appliance is under guarantee, and the repair is covered, it will be repaired at no cost.

Please register as a Dyson appliance owner

To help us ensure you receive prompt and efficient service, please register as a Dyson appliance owner. There are two ways to do this:

- Online at:
www.dyson.co.uk/register
www.dyson.ie/register
- Telephone the Dyson Helpline.
This will confirm ownership of your Dyson appliance in the event of an insurance loss, and enable us to contact you if necessary.

Limited 5 year guarantee

Terms and conditions of the Dyson 5 year limited guarantee

What is covered

- The repair or replacement of your Dyson machine (at Dyson's discretion) if it is found to be defective due to faulty materials, workmanship or function within 5 years of purchase or delivery (if any part is no longer available or out of manufacture Dyson will replace it with a functional replacement part).
- Where this machine is sold outside of the EU, this warranty will only be valid if the appliance is used in the country in which it was sold.
- Where this machine is sold within the EU, this warranty will only be valid (i) if the appliance is used in the country in which it was sold or (ii) if the appliance is used in Austria, Belgium, France, Germany, Ireland, Italy, Netherlands, Spain or the United Kingdom and the same model as this appliance is sold at the same voltage rating in the relevant country.

What is not covered

Dyson does not guarantee the repair or replacement of a product where a defect is the result of:

- Accidental damage, faults caused by negligent use or care, misuse, neglect, carelessness or operation or handling of the appliance which is not in accordance with the Dyson Operating Manual.
 - Use of the appliance for anything other than normal domestic household purposes.
 - Use of parts not assembled or installed in accordance with the instructions of Dyson.
 - Use of parts and accessories which are not genuine Dyson components.
 - Faulty installation (except where installed by Dyson).
 - Repairs or alterations carried out by parties other than Dyson or its authorised agents.
 - Blockages – please refer to the Dyson Operating Manual for details of how to look for and clear blockages.
 - Normal wear and tear (e.g. fuse, brush bar etc.).
 - Use of this appliance on rubble, ash, plaster.
- If you are in any doubt as to what is covered by your guarantee, please contact the Dyson helpline.

Summary of cover

- The guarantee becomes effective at the date of purchase (or the date of delivery if this is later).
- You must provide proof of (both the original and any subsequent) delivery/purchase before any work can be carried out on your Dyson appliance. Without this proof, any work carried out will be chargeable. Keep your receipt or delivery note.
- All work will be carried out by Dyson or its authorised agents.
- Any parts which are replaced by Dyson will become the property of Dyson.
- The repair or replacement of your Dyson appliance under guarantee will not extend the period of guarantee.
- The guarantee provides benefits which are additional to and do not affect your statutory rights as a consumer.

Important data protection information

When registering your Dyson product:

- You will need to provide us with basic contact information to register your product and enable us to support your guarantee.
- When you register, you will have the opportunity to choose whether you would like to receive communications from us. If you opt-in to communications from Dyson, we will send you details of special offers and news of our latest innovations. We never sell your information to third parties and only use information that you share with us as defined by our privacy policies which are available on our website: privacy.dyson.com

Important!

Wash filter

Wash filter with cold water at least once every month.

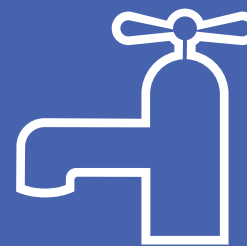

Dyson customer care

If you have a question about your Dyson appliance, contact us via the Dyson website or call the Dyson customer care helpline with your serial number and details of where and when you bought the appliance.

Dyson contact details

UK:

Website: www.dyson.co.uk/support

Dyson helpline:

0800 298 0298

Email:

askdyson@dyson.co.uk

Address:

Dyson Technology Limited, Tetbury Hill, Malmesbury, Wiltshire,
SN16 0RP

ROI:

Website: www.dyson.ie/support

Dyson helpline:

01 475 7109

Email:

askdyson@dyson.ie

Address:

Dyson Ireland Limited, Office 2, Central Park, Leopardstown,
Dublin 18, Ireland

Serial number

Date of purchase / / Country of purchase UK ROI

Title Surname

First name

Address

Postcode

e-mail

Telephone Mobile

As a Dyson vacuum cleaner owner, you can hear about Dyson inventions, services and products before anyone else. If it's okay to contact you, please let us know how we may do this.

By mail Yes No

By phone Yes No

By email Yes No

By text message Yes No

We sometimes ask other companies (such as market researchers) to contact owners on our behalf. We do this to get feedback on ideas or ask you to try new products and services. Would this be okay?

Yes No

3 easy ways to register your free 5 year guarantee

Register online 

Visit our website to register your full parts and labour guarantee online.

www.dyson.co.uk/register
www.dyson.ie/register

Register by phone 

Call our dedicated helpline. Open Monday to Friday 8am-8pm & Saturday and Sunday 8am-6pm.

UK: 0800 298 0298
 ROI: 01 475 7109

Register by mail 

Complete and return the form to Dyson in the envelope supplied.

